



US005389101A

# United States Patent [19]

[11] Patent Number: **5,389,101**

Heilbrun et al.

[45] Date of Patent: **Feb. 14, 1995**

- [54] **APPARATUS AND METHOD FOR PHOTOGRAMMETRIC SURGICAL LOCALIZATION**
- [75] Inventors: **Mark P. Heilbrun; Paul McDonald; J. Clayton Wiker; Spencer Koehler; William Peters**, all of Salt Lake City, Utah
- [73] Assignee: **University of Utah**, Salt Lake City, Utah
- [21] Appl. No.: **871,382**
- [22] Filed: **Apr. 21, 1992**
- [51] Int. Cl.<sup>6</sup> ..... **A61B 5/055**
- [52] U.S. Cl. .... **606/130; 128/653.1**
- [58] Field of Search ..... **128/653.1, 665, 653.2; 606/130; 364/413.13; 324/309, 318**

tion to image analysis," *Advanced Imaging*, Nov. pp. 52-56 Nov. 1990.

*Primary Examiner*—Lee S. Cohen  
*Assistant Examiner*—Samuel Gilbert  
*Attorney, Agent, or Firm*—Trask, Britt & Rossa

## [57] ABSTRACT

A method and apparatus for defining the location of a medical instrument relative to features of a medical workspace including a patient's body region are described. Pairs of two-dimensional images are obtained, preferably by means of two video cameras making images of the workspace along different sightlines which intersect. A fiducial structure is positioned in the workspace for defining a three dimensional coordinate framework, and a calibration image pair is made. The calibration image pair comprises two 2D projections from different locations of the fiducial structure. After the calibration image pair is made, the fiducial structure is removed. A standard projection algorithm is used to reconstruct the 3D framework of the fiducial structure from the calibration image pair. Appropriate image pairs can then be used to locate and track any other feature such as a medical instrument, in the workspace, so long as the cameras remain fixed in their positions relative to the workspace. The computations are desirably performed with a computer workstation including computer graphics capability, image processing capability, and providing a real-time display of the workspace as imaged by the video cameras. Also, the 3D framework of the workspace can be aligned with the 3D framework of any selected volume scan, such as MRI, CT, or PET, so that the instrument can be localized and guided to a chosen feature. No guidance arc or other apparatus need be affixed to the patient to accomplish the tracking and guiding operations.

## [56] References Cited

### U.S. PATENT DOCUMENTS

|           |         |                |             |
|-----------|---------|----------------|-------------|
| 4,551,678 | 11/1985 | Morgan et al.  | 128/653.2 X |
| 4,583,538 | 4/1986  | Onik           | 606/130     |
| 4,618,978 | 10/1986 | Cosman         | 606/130     |
| 4,638,798 | 1/1987  | Shelden et al. | 128/653.1   |
| 4,884,566 | 12/1989 | Mountz et al.  | 606/130     |
| 4,945,914 | 8/1990  | Allen          | 128/653.1   |
| 5,005,578 | 4/1991  | Greer et al.   | 324/318     |
| 5,107,839 | 4/1992  | Houdek et al.  | 128/653.1   |
| 5,178,146 | 1/1993  | Giese          | 128/653.2   |

### OTHER PUBLICATIONS

H. Bopp, "An orientation and calibration method for non-topographic applications," *Photogrammetric Engineering and Remote Sensing*, vol. 44, No. 9, Sep. 1978, pp. 1991-1196.

H. Johnson, "The mechanical Engineer and the transi-

30 Claims, 4 Drawing Sheets

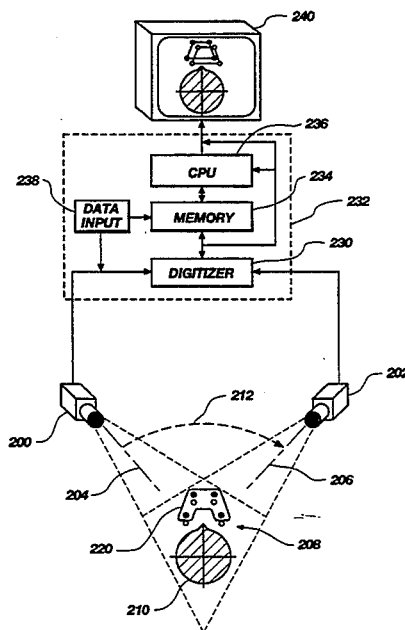

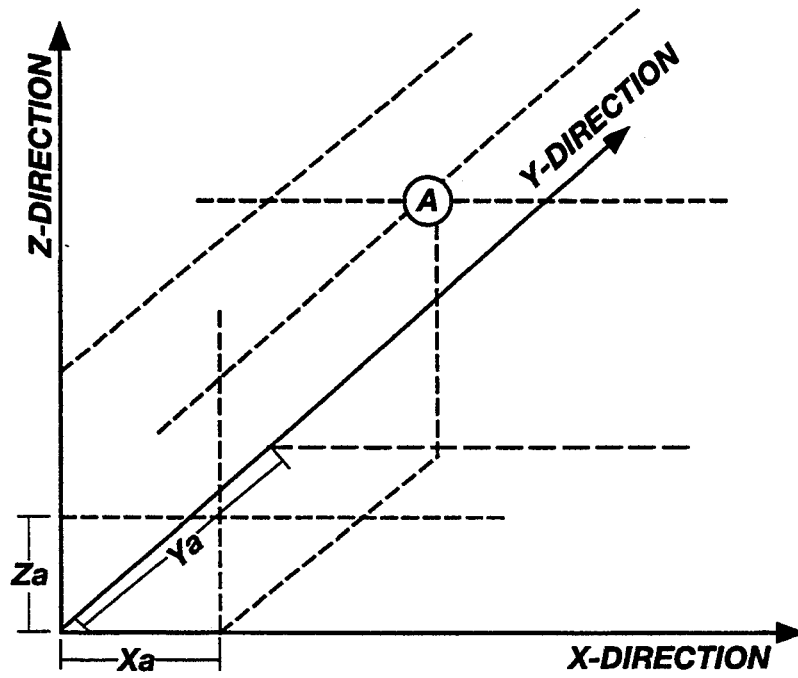

Fig. 1B

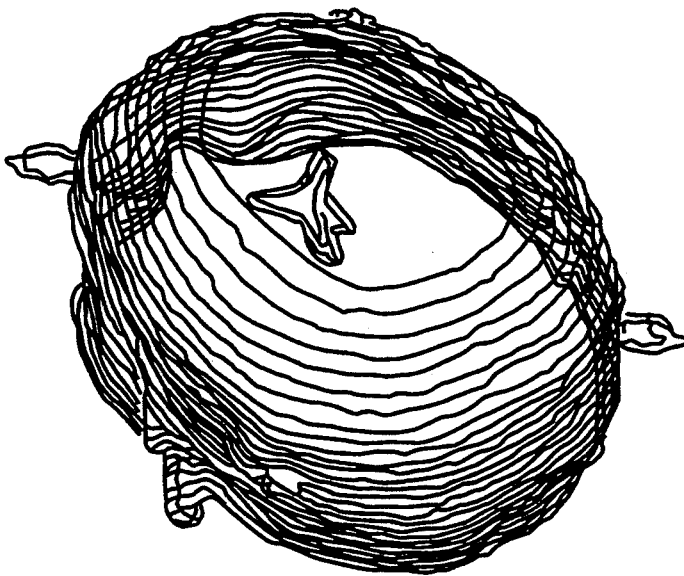

Fig. 1A

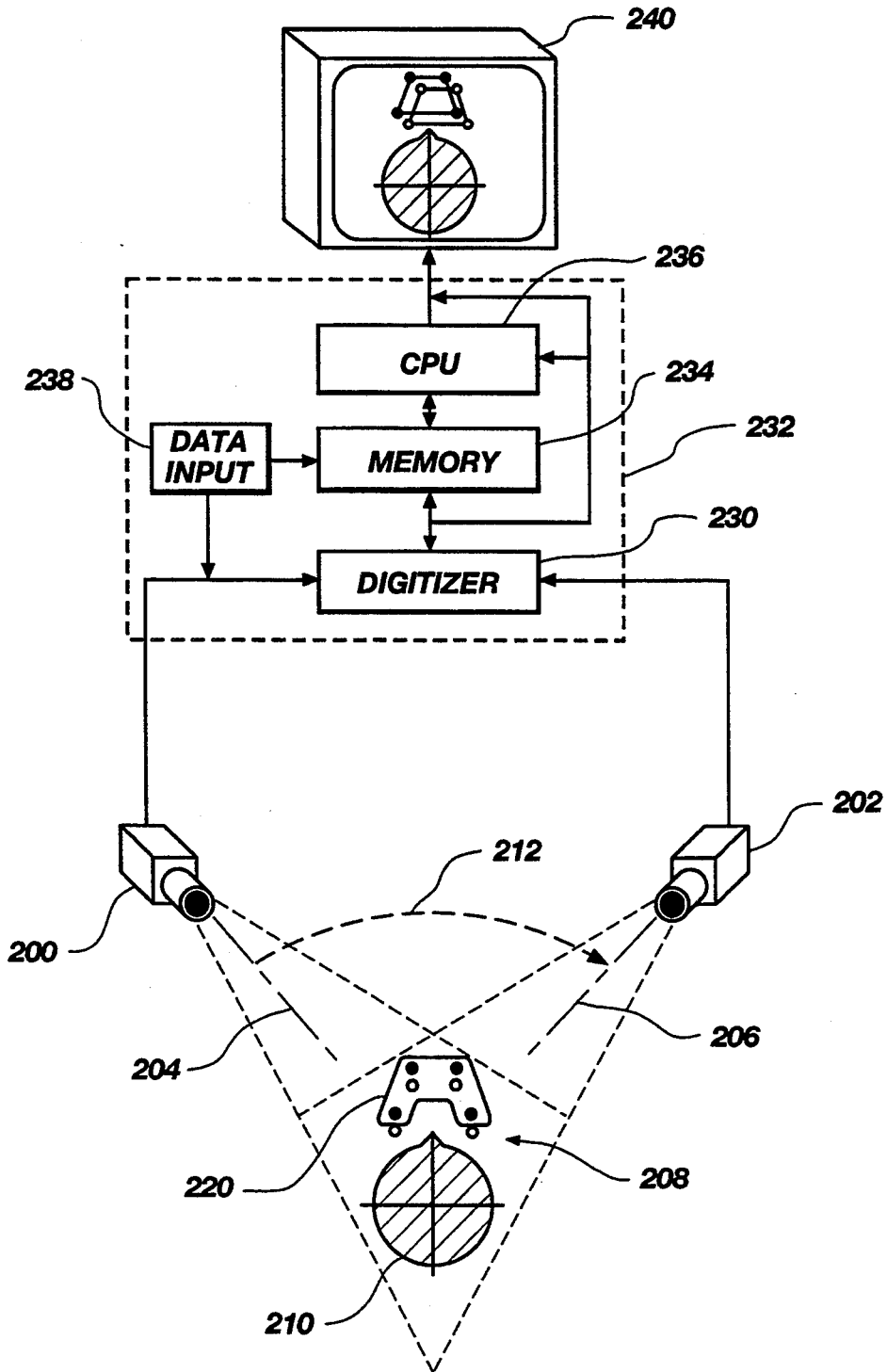
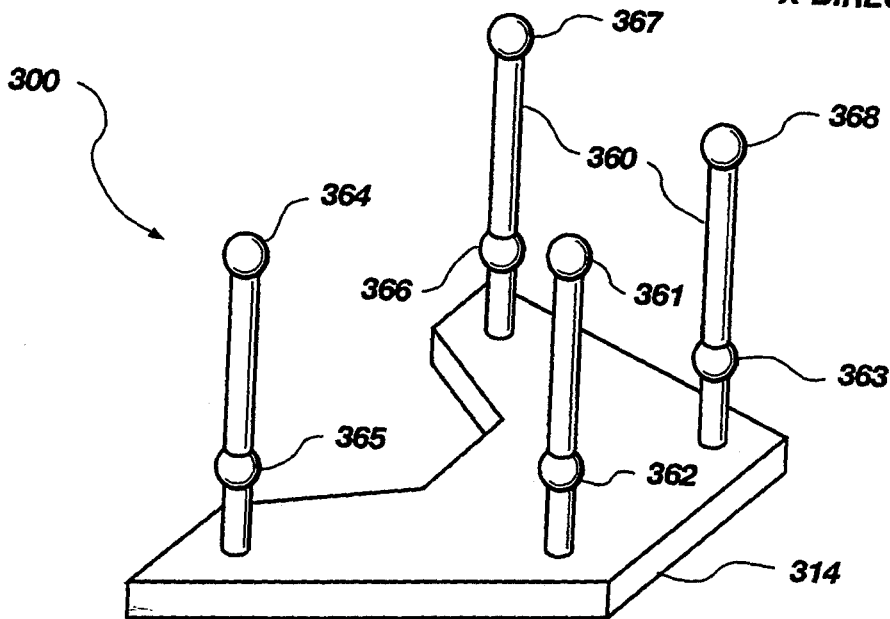
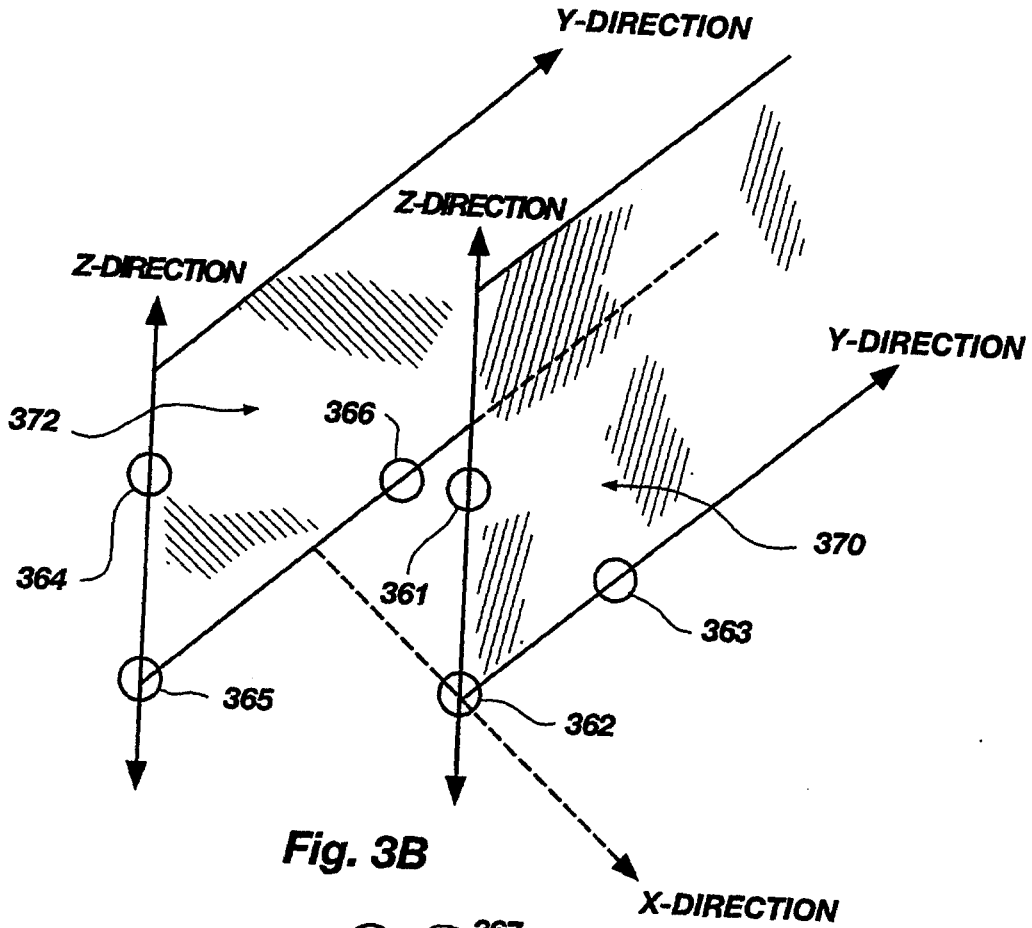

Fig. 2



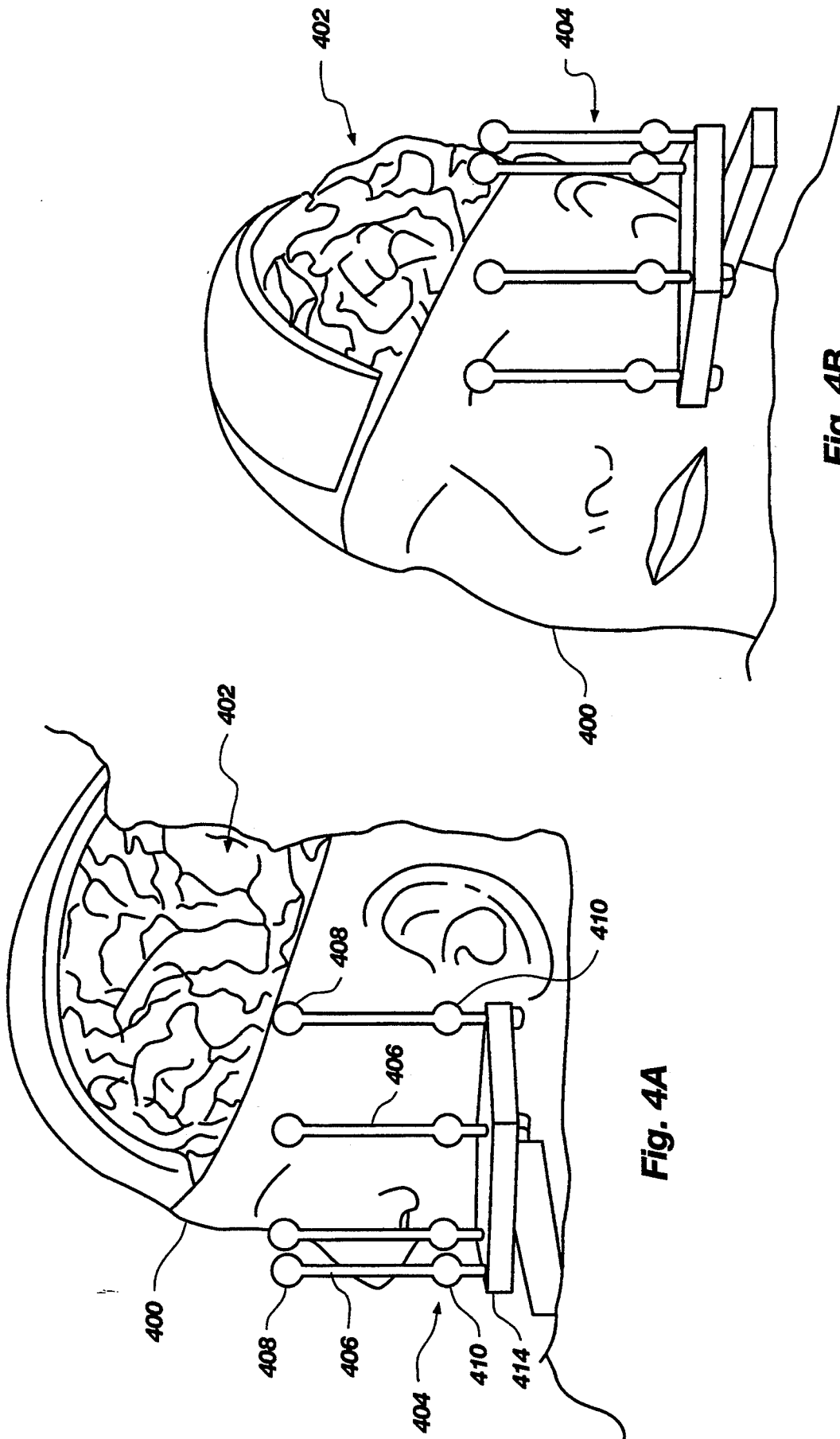

Fig. 4A

Fig. 4B

## APPARATUS AND METHOD FOR PHOTOGAMMETRIC SURGICAL LOCALIZATION

### BACKGROUND OF THE INVENTION

#### 1. Field

The application is related to techniques for mapping internal structures in the body of an animal or human, and more particularly to such technique for localizing a medical instrument with respect to anatomical features or the like during surgical or other medical procedures.

#### 2. State of the Art

Various scanning apparatus and methods are known for imaging and mapping body structures, which provide target location data for surgical and other medical procedures. One group of methods, including still photography, videography, radiological x-rays, and angiography, typically produces only a two-dimensional projection of a three-dimensional object. For purposes of this application, this first group will be termed "two-dimensional" or "2D" imaging.

A second group of methods, of which computerized tomographic (CT) scanning, positron emission tomography (PET) scans, and magnetic resonance (MRI) imaging are exemplary, provide three-dimensional (abbrev. "3D" herein) information about internal structures (i.e., structures not visible from the exterior of the patient). The three-dimensional information about the internal volume is reconstructed from multiple scans of a known thickness (generally about a millimeter) made along parallel planes displaced from each other by a known distance, usually of the order of millimeters. An example of such a reconstructed volume image is depicted in FIG. 1A, including the contours of a selected anatomical feature within the brain. In this application, methods in this second group will be referred to as "volume" scanning or imaging.

In performing resection or other surgical manipulations, it is highly desirable to correlate the location of instruments, patient anatomical features, or other elements or structures placed in the surgical field, and generally as seen by the surgeon, with the location of internal targets or features as visualized by one of the volume scanning techniques. Such a correlation process is often termed "localization".

A commercially available device for localization in neurosurgery is the Brown-Roberts-Wells (abbrev. BRW) localizer (U.S. Pat. Nos. 4,341,220, and 4,608,977). The BRW system includes a large ring-like structure which surrounds the patient's head and is fixed in place. The ring establishes a 3D coordinate system with respect to the patient's head. A separate calibration unit having an array of rod elements is fixed to the ring to surround the head during the production of volume scan and/or 2D images. The rod elements have known coordinates in the 3D coordinate system established by the ring, and produce spots in the volume scans. Other features in the volume scans can then be assigned coordinates in the 3D coordinate system established by the ring, by correlation with the known coordinates of the rod elements producing the spots.

After the images are made, the calibration unit is detached from the ring, and a guidance arc calibrated to the 3D coordinate system of the ring is attached in its place. The guidance arc provides coordinate reference information which may be used to guide a medical

instrument. The medical instrument is usually attached to the guidance arc.

The BRW system has several disadvantages. The ring is cumbersome and uncomfortable for the patient, but it must be affixed in place when the volume and/or 2D scans are made, and kept there until the medical procedure is complete. It is possible to remove the ring after the scans are made, but precise repositioning is critical to avoid error in localization. Accurate repositioning is difficult, so present practice generally is to keep the ring in place until after the surgery. When not attached to the guidance arc, the position of a medical instrument in terms of the 3D coordinate system of the ring, and therefore in respect to the features identifiable in the volume or 2D scan, is not accurately known.

U.S. Pat. No. 4,618,978 to Cosman discloses a localizer device for use with a BRW-type system, including an open box composed of connected rods, which surrounds the patient's head and constitutes a calibration unit.

Alternatively, cranial implants of radio-opaque or MRI-opaque materials can be made. Generally, a minimum of three implants are required for establishing a three-dimensional space in volume scans. At present this method is considered very undesirable, in part because of the risk of infection or other complications of the implants.

Accordingly, a need remains for rapid, reliable, and inexpensive means for localizing a medical instrument relative to points of interest including both visible anatomical features and internal features imaged by volume and/or 2D methods. A need further remains for such means which does not require the physical attachment of a reference unit such as the BRW ring to the patient. Highly desirably, such means would be useful to track the position of a medical instrument in real time, and without requiring that the instrument be physically attached to a reference guide.

### OTHER TERMS AND DEFINITIONS

A coordinate system may be thought of as a way to assign a unique set of numerical identifiers to each point or object in a selected space. The Cartesian coordinate system is one of the best known and will be used in this paragraph by way of example. In the Cartesian coordinate system, three directions  $x$ ,  $y$ ,  $z$  are specified, each corresponding to one of the three dimensions of what is commonly termed 3D (three-dimensional) space (FIG. 1B). In the Cartesian system, any point can be identified by a set of three values  $x$ ,  $y$ ,  $z$ . The  $x$ ,  $y$  and  $z$  directions can be said to establish a "three-dimensional framework" or "coordinate framework" in space. A selected point "A" can be described in terms of its values  $x_a$ ,  $y_a$ ,  $z_a$ ; these values specify only the location of point A. A different point B will have a different set of values  $x_b$ ,  $y_b$ ,  $z_b$ . Such a set of values  $x,y,z$  for any selected point is referred to herein as the "coordinates" or "locational coordinates" of that point. When the position of a feature larger than a single point is being described, these terms are also understood to refer to a plurality of sets of  $x,y,z$  values. Other types of coordinate systems are known, for example spherical coordinate systems, and the terms "coordinates" and "locational coordinates" should further be understood to apply to any set of values required to uniquely specify a point in space in a given coordinate system.

The term "fiducial" is used herein as generally understood in engineering or surveying, to describe a point or

marking, or a line, which is sufficiently precisely defined to serve as a standard or basis reference for other measurements.

### SUMMARY OF THE INVENTION

The invention comprises apparatus and a method for defining the location of a medical instrument relative to elements in a medical workspace including a patient's body region, especially (but not limited to) elements seen by the surgeon. The apparatus develops a calibrated 3 dimensional framework of the workspace from a pair of 2D images made from different fixed locations, and aligns the workspace framework with a 3D scan framework defined by a volume scan. A pair of video cameras is the present preferred imaging means for obtaining the 2D image pairs. The apparatus is then operable to locate and track the position of a medical instrument during a medical procedure, with respect to features observable in either the workspace images or in the volume scan. A pictorial display of such location and tracking information is provided to aid a medical practitioner performing the procedure.

The apparatus may be described as follows. Workspace imaging means are provided and positioned for producing a plurality of pairs of 2-dimensional images of a medical workspace. Each image pair comprises two such images made in effect simultaneously along respective different sightlines which intersect at an angle. Digitizing means are operably disposed for digitizing each image to produce corresponding sets of digital output signals, one set for each image.

Calibration means are removably positionable in the workspace for calibrating the workspace in terms of a three-dimensional coordinate framework. The 3D workspace framework is derived by computation from the two 2D projections of an image pair made with the calibration means positioned in the workspace. The calibration means comprises at least six fiducial points held in fixed spatial relation to each other, and having known spatial parameters which define an arbitrary Cartesian 3-dimensional coordinate system. These spatial parameters include 3D location coordinates of each of the fiducial points. Optionally but desirably, at least some of the actual distances between fiducial points should be known, to calibrate the workspace in terms of a suitable distance unit such as millimeters.

A computing means is connected to receive the digital output signals reflective of the images. The computing means also has data input means for receiving scan data from a volume scan of the patient's body region. The scan data define a scan 3D coordinate framework and internal anatomical structures therein. The computing means is further constructed or programmed to perform the following steps: 1) establish a workspace coordinate framework in three dimensions from an image pair made with said fiducial structure positioned within the workspace; 2) determine the locational coordinates in the workspace framework of any selected point which can be identified from both images of said pair; 3) correlate the scan locational coordinates for each of three or more selected landmarks observable in the scan with the workspace locational coordinates of the same landmarks as derived from a video image pairs; 4) use the correlation of the workspace coordinates and the scan coordinates of the landmarks, to derive a transformation algorithm for mapping selected other features from either the scan framework to the workspace framework, or the converse; and 5) provide display

signals encoding a display reflective of one or both of the workspace images and/or a volume scan, as selected by a user. Display means are provided for displaying the images encoded by the display signals.

Optionally but highly desirably, the computing means has computer graphics capability for producing graphic icons overlaid upon the displayed images. Such icons include a cursor which the user employs to select features in the displayed images for computation of their coordinates or other operations.

A method of surgical guidance may be described as follows. First, a fiducial structure having six or more fiducial points defining two distinct, non-orthogonal planes is positioned in a medical workspace. Workspace imaging means are disposed for making pairs of two-dimensional images of the workspace in which the two member images are made along different but intersecting sightlines. A calibration image pair comprising images of the workspace with the fiducial structure is made. The fiducial structure is removed from the workspace.

A projection algorithm is applied to reconstruct a workspace 3D coordinate framework from the calibration image pair. At least one additional 3D scan framework is obtained from a corresponding volume scan of the patient's body region. At least three landmarks identifiable in both the volume scan and the workspace image pair are selected, and the coordinates for the three landmarks are determined in both the workspace framework and the scan framework. From these determined coordinates, a process is developed for aligning the scan framework with the workspace framework, and transformation algorithms for converting coordinates from one of the frameworks to the other are computed.

A target of interest in the volume scan is identified, and its scan coordinates are determined and converted to workspace coordinates. A feature of interest in the workspace, such as a fiducial mark on a scalpel, is identified. The workspace coordinates of the fiducial mark and of the scalpel tip (whose distance from the fiducial mark is known), plus a vector describing the direction of the scalpel, are determined. Optionally but highly desirably, both the target and the scalpel including the scalpel tip position are displayed in an image of the workspace. The path of the scalpel tip is extrapolated along the vector for a distance sufficient to determine whether the tip will reach the target on this path. If not, the direction of the scalpel is adjusted and the process of localizing the tip and extrapolating its path is repeated until the extrapolated path is deemed adequate by a user, and/or until the medical procedure is complete.

### BRIEF DESCRIPTION OF THE DRAWINGS

In the figures, which illustrate what is presently regarded as the best mode for carrying out the invention, like reference numbers indicate like elements of the apparatus:

FIG. 1 depicts a volume scan and a coordinate system;

FIG. 2 is a block diagram depicting the basic elements of a video localization system of the invention;

FIG. 3 depicts an embodiment of the fiducial structure in greater detail;

FIG. 4 depicts a pair of images made from different positions of a surgical workspace including a patient's head, with the fiducial structure of the invention positioned for calibrating the workspace.

## DETAILED DESCRIPTION OF THE ILLUSTRATED EMBODIMENT

FIG. 2 is a block diagram depicting the basic elements of a working embodiment of a video localization system of the invention. A pair of video cameras 200, 202 are positioned for making a pair of images along respective sightlines 204, 206, of a medical workspace 208 which includes a patient's body region here shown to be the patient's head 210. Cameras 200, 202 are arranged to have an angle 212 between sightlines 204, 206, such that both cameras image the workspace 208. Workspace 208 is effectively defined by the overlapping fields of view of the respective images made by cameras 200, 202. Angle 212 is preferably between about 30° and 150°. However, any angle greater than zero degrees and not equal to 180° can be used.

Alternatively, cameras 200, 202 may be replaced by a single camera which is moved back and forth between first and second positions to take images along respective sightlines 204, 206. In the latter case, it is important that the camera be precisely positioned in the first and second positions when making the respective images of an image pair. Positioning means may be provided for establishing fixed attachment points for attachment of a camera, to facilitate such repositioning. Whether one camera or two cameras are used, what is significant is that the system takes pairs of images of workspace 208, each member of an image pair made along different sightlines intersecting in workspace 208.

A fiducial structure 220 (described in greater detail with reference to FIG. 3) is shown positioned in the workspace 208 proximal to the head 210. During use, fiducial structure 220 can be held in position by any suitable support means (not shown). One suitable support means would be a bar with a clamp arm attached to a ring stand or the like. Notably, fiducial structure 220 is neither affixed to, nor in contact with, the patient's head 210. Fiducial structure 220 may be removed from workspace 208 when it is not required.

Cameras 200, 202 are communicatively connected to image digitizing means 230, which produces two sets of digitized image signals, each representative of a respective image detected by one of the two cameras. Digitizing means 230 is in turn connected to send the digitized image signals to computing means 232.

Computing means 232 receives the digitized image signals from digitizing means 230 and is operable in response to compute display signals representative of the digitized video image(s) of workspace 208 as seen by one or both of cameras 200, 202. Computing means 232 comprises at least a central processing unit, memory means which includes both volatile and nonvolatile memory components, data input means, an image processing/computer graphics subunit, and output means for outputting display signals. The foregoing components of computing means 232 are functionally interconnected generally as known in the art of computing. In a further embodiment, computing means 232 is operable to combine images of the workspace made from each of the two different positions to produce a single stereo image.

Computing means 232 supplies the display signals to a display unit 240 which may be a video display, a CRT monitor, or the like. Display unit 240 converts the display signals to a video image of the workspace 208 as seen by either or both of cameras 200, 202. Display unit 240 is positioned for ready viewing by medical person-

nel performing procedures in the workspace. Preferably, display unit 240 is constructed to provide sufficient resolution to adequately distinguish significant components in images of the workspace 208. In FIG. 2, display unit 240 is depicted as having a single viewing screen showing the image as seen by camera 200. This embodiment is provided with a single screen for displaying visual depictions of the available scans and images. These may include the image made by camera 200, the image made by camera 202, scan images derived from volume scanning methods, X-ray images made by X-rays and including angiograms, etc., as selected by a user operating computing means 232. The user may switch the display from one to another of the various visual depictions, as desired. Also, one or more features of a first selected depiction, or the entire first selected depiction, can be overlaid on a second selected view.

Alternatively, display unit 240 may contain a plurality of viewing screens arranged for simultaneously displaying in separate screens, the selected depictions.

Computing means 232 also provides graphic display signals to the display unit 240, to produce graphic icons overlaid upon the selected displayed image. The graphic icons should include a cursor which can be positioned by the user at a feature of interest in the displayed image.

Computing means 232 is further constructed, or alternatively programmed, to compute a workspace coordinate framework which defines workspace 208 in terms of three-dimensional Cartesian coordinates in useful distance units, for example millimeters. The workspace coordinate framework is computed from the two digitized 2-dimensional images of the fiducial structure 220 provided respectively by cameras 200, 202, plus the known location parameters of fiducial points on fiducial structure 220 (described in more detail in reference to FIG. 3). In the working embodiment, computing means 232 performs these computations according to a well-known projection algorithm, originally developed by Bopp and Krauss (Bopp, H., Krauss, H., An orientation and calibration method for non-topographic applications, *Photogrammetric Engineering and Remote Sensing*, Vol. 44, Nr. 9, Sept. 1978, pp. 1191-1196).

The memory means of computing means 232 is constructed or programmed to contain the known location parameters of fiducial structure 220, which are required for performance of the computations producing the workspace coordinate framework from the two 2D images. In the working embodiment, these known location parameters include three-dimensional Cartesian coordinates for each of the fiducial points and the actual distances between some of the fiducial points as measured from fiducial structure 220. The latter distances are not required for establishing the workspace framework, but are used to calibrate the framework in terms of useful real distance units.

Once the workspace coordinate framework has been computed, computing means 232 is further operable to compute the 3D location coordinates within the workspace framework of any feature of interest whose position may be observed by means of the images made with both of cameras 200, 202. Such workspace location coordinates will be accurate provided the two images are made from substantially the same positions relative to workspace 208 as during the establishment of the three-dimensional framework with the fiducial structure.



Features which can be observed by means of the images made by cameras 200, 202 include both features actually seen in both images, and features which are not within the field of view of one or both images but whose position can be indicated by use of a pointer with at least two fiducial marks, where the distance between at least one of the fiducial marks and the tip of the pointer is known. Two fiducial marks are needed to establish the direction with respect to the workspace coordinate framework, of a vector representing the linear direction of the pointer. Alternatively, any other marker(s) useful to compute the vector direction may be employed.

Examples of features of interest include externally-placed portions of scan markers used for volume and/or 2D scans, anatomical features on or within the patient including skull surface contours, marks on the patient's skin, medical instruments and devices, etc.

Computing means 232 further has data input means 238 for receiving data representing one or more scans produced by volume imaging methods (PET, MRI, CT) and/or by 2D imaging methods (X-rays, angiograms) etc. In an alternate embodiment, computing means digitizes the CT and/or MRI volume scans and integrates the digitized volume data to establish the volume scan 3D coordinate system.

Once the workspace coordinate framework and any volume scan coordinate framework(s) have been established, computing means 232 is further operable to apply standard mathematical methods to align the scan coordinate framework(s) with the workspace framework. Knowledge of the coordinates in both the scan framework and the workspace framework of each of three selected landmarks is required and is sufficient for the alignment. Such landmarks may be anatomical features, scan markers which produce distinctive spots in the scan, or any other feature which can be unequivocally identified in both the images made by the imaging means and in the scan.

Using information derived from the mathematical operations used to align the volume scan framework with the workspace framework, computing means 232 is further operable to derive-transformation functions for converting scan location coordinates describing the position of a selected point in terms of the scan framework, to workspace location coordinates which describe the position of the same selected point in terms of the workspace framework. A term used in the art for this conversion process, which will also be used for purposes of this application, is "mapping" of coordinates from one framework to another.

Computing means 232 may also perform the converse operation, e.g. to map coordinates of a selected point from the workspace framework to the volume scan framework.

In a further embodiment, the system includes means for attaching at least two fiducial marks to instrument(s) to be used in the workspace. Alternatively, a set of instruments having at least two fiducial marks may be provided as part of the system. These fiducial marks permit tracking of the position of an operative portion of the instrument and extrapolation of its path. These operations will be described in greater detail hereinafter. In still another embodiment, features normally present on a medical instrument may be used as the fiducial marks, provided the distance between at least one of such marks and the operative portion is measured and provided to computing means 232.

In the working embodiment depicted in FIG. 2, which is a currently preferred embodiment, computing means 232, digitizing means 230, and display unit 240 take the form of a computer workstation of the type commercially available, having standard image processing capability and a high-resolution monitor. In this embodiment, the digitizing of all of the images made by the workspace imaging means, digitizing of the volume scan data, establishment of the workspace coordinate framework, and other functions described herein for computing means 232, may be accomplished in large part or entirely by appropriate software means stored in the memory portion of the computer workstation.

When an image of the fiducial structure is taken by an optical imaging means such as a video camera or X-ray machine, a two dimensional projection of the structure is produced. If two such images (an image pair) are taken at different angles, for example by cameras 200, 202 in FIG. 2, the two 2D projections can be used to reconstruct the three dimensional coordinate system of the fiducial structure, using any suitable photogrammetric projection algorithm.

In the working embodiment, the photogrammetric projection computations are based upon a well-known projection algorithm (Bopp, H., Krauss, H., An orientation and calibration method for non-topographic applications, *Photogrammetric Engineering and Remote Sensing*, Vol. 44, Nr. 9, Sept. 1978, pp. 1191-1196), which has previously been applied to derive from X-ray images a coordinate system referenced to a BRW-type ring localizer (Siddon, R., and Barth, N., "Stereotaxic localization of intracranial targets", *Int. J. Radiat. Oncol. Biol. Phys.* 13:1241-1246, 1987; P. Suetens et al., "A global 3D image of the blood vessels, tumor, and simulated electrode", *Acta Neurochir.* 33:225-232, 1984; D. Vandermeulen et al., "A new software package for the microcomputer based BRW stereotactic system: integrated stereoscopic views of CT data and angiograms", *SPIE* 593:106-114, 1985).

It should be noted that while the fiducial structure, the method and the computations are described primarily with reference to a Cartesian coordinate system, other types of 3D coordinate systems may be used instead. Such alternate coordinate systems include spherical coordinates, cylindrical coordinates, and others. Any of these alternate coordinate systems could be applied in place of the Cartesian system, with appropriate changes in the projection computations, to accomplish essentially the same goals in substantially the same way. The fiducial structure would be used in essentially the same way. However, depending on the type of coordinate system employed, other arrangements of the fiducial points of the fiducial structure may be desirable. For example, with a spherical coordinate system, fiducial points presented as a spheroidal array instead of a box-like array, might be more convenient for the computations. Also, the minimum or sufficient number of fiducial points required for the projection computation may differ for different projection algorithms. The number of required fiducial points would be evident from the projection algorithm selected.

To utilize the projection technique of Bopp and Krauss in a Cartesian system, the fiducial structure should meet the following criteria. First, the fiducial structure must have at least six fiducial points arranged to define two distinct planes. Second, the actual coordinates of each of the individual fiducial points must be known and must be fixed relative to the other fiducial

points. Optionally but highly desirably, the linear distance between at least one pair of fiducial points should be measured from the fiducial structure and stored in the computing means, to provide a distance reference to calibrate the workspace in terms of real distance units. However, other methods of calibrating the workspace in distance units could be used.

In the embodiment of FIG. 3, fiducial structure 300 has four rods 360 each having respective upper and lower ends 310, 320. Eight fiducial points 361, 362, 363, 364, 365, 366, 367, 368 are formed as balls on rods 360. Each of rods 360 is fixed at its lower end 310 to a plate 314. The attachment of rods 360 to plate 314 may be either detachable or permanent.

In the illustrated embodiment, planes 370, 372 are shown as being parallel; this is not required, but the planes cannot be orthogonal to each other. It is believed that the greatest accuracy in the mathematical calculations will be achieved if the planes are parallel or near to parallel.

An arrangement of the fiducial points in parallel planes and along lines perpendicular to those planes to form an open square or rectangular box provides a simple configuration for defining the coordinates of the fiducial points within the coordinate framework of the calibration unit. However, the trapezoidal arrangement depicted in FIG. 3 is currently preferred. In use, the trapezoidal fiducial structure of FIG. 3 is placed with fiducial points 364, 365, 366 rearward and closer to the patient, and fiducial points 361, 362, 363 forward and nearer to the workspace imaging means. The arrangement having the "rearward" fiducial points of the fiducial structure spread farther apart than the forward points is believed to be easier to position such that none of the fiducial points is obscured or blocked in either of the images made by cameras 200, 202. In a further preferred embodiment, the "rearward" fiducial points are constructed to be distinguishable from the "forward" fiducial points. This may be accomplished by making them of differing shapes (say boxes vs. balls), differing colors, etc.

The connecting elements constituted by rods 360 of FIG. 3 need not be arranged as a trapezoid, a rectangle or any other regular figure. Nor is it required that the fiducial points in the first plane be positioned directly above the points in the second plane. It will also be apparent that the fiducial structure need not have a plate such as plate 314, rods such as rods 360, or fiducial points shaped as balls as in FIG. 3. All that is required is a minimum of six fiducial points arranged to satisfy the conditions described in the preceding paragraphs, and means for holding the fiducial points in fixed relation to each other. A rather different construction might for example be a clear plastic box-like structure with fiducial elements, either brightly visible marks or shapes such as balls, at appropriate corners. The fiducial identifiers need not be balls as shown in FIG. 3, but could be other shapes, including pyramids or boxes; markings on rods such as rods 360; vertices at the interconnections of rod-like elements, etc.

Optionally but desirably, as in the embodiment of FIG. 3, there are two additional fiducial points 367, 368, beyond the six required for the computations. The "extra" fiducial points may be used to verify that the computation of locational coordinates from the camera images is correct.

FIGS. 4A and 4B depict one embodiment of a fiducial structure as it would be seen in video and/or CRT

displays of the respective images as seen by cameras 200, 202, of a workspace including a patient's head. The patient's head 400 has an exposed portion of the brain 402 which serves as the point of entry for a surgical procedure, and a fiducial structure 404 positioned adjacent thereto.

In a still further embodiment, a grid representing the workspace coordinate framework may be projected onto the workspace by means of a light projector analogous to a common slide projector, but using more concentrated light. Still another embodiment includes a spot projector like a laser spot, which projects a bright or colored spot onto the surface of the patient, the spot being detectable in image pairs made by the camera(s), and accordingly localizable by the same means as any other selected feature in the workspace. This spot projector can be aimed by a user to select a spot whose workspace coordinates it is desired to determine, or automatically by the computing means to indicate the coordinate location of a feature selected from another scan such as a volume scan.

The apparatus so designed is also functional to convert from a 3D coordinate framework established from two video 2D images, to a second 3D coordinate framework established from a similar pair of X-ray 2D images made with a calibration unit that has radio-opaque fiducial points. These X-ray images could be standard-type radiological X-rays, or angiograms. This X-ray coordinate framework can further be aligned with a volume scan framework in the same manner as for the video framework, and location coordinates of features in the X-ray images transformed to video coordinates or volume scan coordinates, as desired.

A sequence of steps of a method of localizing and guiding surgical instruments is described as follows, referring as needed to FIG. 2. The first step is to position cameras 200, 202 for viewing a medical workspace 208. The angle 212 between the sightlines 204, 206 is preferably from about 30 degrees to about 150 degrees.

Next, the fiducial structure is positioned within the workspace so as to have at least six fiducial points visible to both cameras. A pair of images is made in effect simultaneously, of the workspace with the fiducial structure therein, to produce a calibration image pair. The images from the respective cameras are digitized and 2 dimensional coordinates for each of the fiducial points in the 2D images made by each of cameras 200, 202 are determined. A projection algorithm, which in a working embodiment of the method is the Bopp-Krauss projection algorithm previously referenced herein, is then used to mathematically reconstruct a workspace 3D coordinate framework from the 2D coordinates from both images of the calibration image pair, plus the known location parameters of the fiducial points in the fiducial structure. The projection algorithm is optimized using a least-squares approach. All of the foregoing computations, and those described later, may desirably be performed by operating a computer workstation configured similarly to computing means 232.

Generally, it is preferred to make the calibration workspace image pair with the fiducial structure and the patient in the workspace, because it is easier to ensure that the desired body region of the patient is adequately centered within the workspace defined by the edges of the camera views. However, it is not required that the patient be in the workspace when the calibration image pair is made.

The fiducial structure 220 may be removed from the medical workspace 208 at any time after the calibration image pair has been made, so long as all subsequent image pairs are made from the same two locations.

Scan data from one or more volume scans in a corresponding scan 3D coordinate framework are then provided to the computer. These scan coordinates may be previously stored in a memory unit within, or operably associated with, the computer, or may be supplied at this time through an external data input. The workspace coordinates and scan coordinates of at least three points which can be identified in both the workspace 3D framework and in the scan 3D framework are obtained and are used to make the alignment computations. These three points may be portions of the scan markers used in the internal scans which are also visible to both cameras in the workspace. Alternatively, anatomical features of the patient which can be pinpointed on both the visual images and the volume scans may be used.

The computations for alignment of the two frameworks and transformation of coordinates from one framework to the other uses a linear algebra approach as described in theory and algorithmic solution in standard mathematical texts. Following alignment of the volume scan framework with the workspace framework, coordinates in the workspace framework are determined for one or more medical target(s) in the workspace.

A medical instrument to be used in the procedure is provided with at least two fiducial marks which are visible to both cameras during the procedure. The physical distance between at least one of the instrument fiducial marks and the significant or operative portion(s) of the instrument whose position it is desired to monitor, must be known. Such an operative portion might for example be the cutting tip of a scalpel. In the next step of the method, the locational coordinates in the workspace framework of the instrument fiducial marks are determined. From these coordinates and the known physical distance between one of the instrument fiducial marks and the tip of the instrument, the coordinates of the location of the instrument tip are determined. The location of the instrument tip relative to the location of the target is thereby established.

The position of the instrument including the tip, relative to the target and other structures within the workspace is then displayed for viewing by the person guiding the instrument. Optionally, from the line constituted by the two instrument fiducial marks, the path of the instrument if it moves further along that line from its present position is extrapolated to determine whether it will approach a desired target whose workspace coordinates are known.

To guide the instrument tip to the desired target, a navigational procedure analogous to the landing of an aircraft on a runway is performed. The workspace coordinates of the tip are determined repeatedly as the instrument is moved, and the position of the instrument and its tip are displayed relative to the target. As necessary, the direction of travel of the instrument is adjusted, the path in the new direction is extrapolated, the instrument tip is moved and its location again determined. With sufficient speed in computation, it is expected that the system will be able to provide monitoring and navigation on a time-scale approaching or substantially reaching real-time. Such a real-time system would be highly preferred.

Table I presents results of accuracy tests of the localization apparatus and system. The tests were performed by comparing the 3D location coordinates derived using the video system with three-dimensional coordinates obtained by physical measurement with a calibrated Brown-Roberts-Wells (BRW) arc and a mockup of a patient's head.

TABLE I

| TEST OF VIDEO LOCALIZER DEFINED TARGET<br>COMPARED TO ACTUAL TARGET AND<br>BRW LOCALIZER DEFINED TARGET |   |  |
|---|---|--|
| ACTUAL<br>STEREOTACTIC<br>COORDINATE  | BRW LOCALIZER<br>STEREOTACTIC<br>COORDINATE | VIDEO<br>LOCALIZER<br>STEREOTACTIC<br>COORDINATE |
| <u>TARGET TEST 1</u>  |   |  |
| AP = 92.6   | AP = 91.3                                   | AP = 92.0  |
| LAT = -6.8  | LAT = -6.5                                  | LAT = -5.8                                       |
| VERT = 14.0   | VERT = 14.9                                 | VERT = 13.2                                      |
| <u>TARGET TEST 2</u>  |   |  |
| AP = -16.0  | AP = -15.7                                  | AP = -17.8                                       |
| LAT = 25.0  | LAT = 24.2                                  | LAT = 26.1                                       |
| VERT = 48.4   | VERT = 48.1                                 | VERT = 48.4                                      |

As indicated by the data in Table 1, the localization results presently obtained with a working embodiment of the invented system are accurate to within at least about 2 millimeters of the locations determined by a conventional BRW localization system.

The system, comprising the apparatus and method for localization, may also be applied to localize and track features responsive to a neuron-stimulating electrode. Such a use is advantageous when the surgeon is attempting to navigate around essential structures such as the speech center in the brain, or to locate or confirm the location of a lesion causing a defect in neural functioning.

A method for using the guidance system to identify a neural lesion in terms of a functional deficit includes the following steps. After the workspace coordinate framework is established and the patient's head is positioned in the workspace and readied for the procedure, an electrode is moved slowly or at selected intervals from one position on the surface of the brain to another. At each position the electrode is activated to stimulate a response. When a functional deficit in the response is observed, the electrode path into the brain is extrapolated for a sufficient distance beyond the electrode tip, to reach the suspected depth of the lesion. The extrapolation is done from at least two fiducial marks associated with the electrode to define its direction. The extrapolated path is presumed to intersect the lesion causing the functional deficit. Movement of the electrode is repeated until at least one more, and desirably two more, surface positions which cause a similar functional deficit are found. A process similar to triangulation is used to determine the location of the lesion from the two or three extrapolated paths.

A process similar to the above may be used to identify a critical area such as a speech center which the surgeon wishes to avoid damaging. The major difference is that instead of extrapolating the electrode path from points where a functional deficit is observed, points where electrode stimulation cause activation of speech in the patient are used for the extrapolation.

Still other uses for the localization apparatus and method include: identifying the position of an ultrasound probe during an ultrasound scan of a segment of

the brain (or other body region); identifying the position of the operative portions of an endoscope, fluoroscope, operating microscope, or the like, during procedures performed with such instruments.

The invention has been described primarily with reference to neurosurgical procedures wherein the medical workspace is the patient's head and brain. However, the technique may also be applied to other medical procedures where precise localization and guidance of medical instruments is desirable. These include plastic surgery, particularly of face and hands, and procedures involving the spine and spinal cord regions.

Moreover, the apparatus (including the fiducial structure) and method are not restricted to uses in a medical or surgical arena, but may further be applied to any procedure in which it is desired to correlate position information which would be available from 2D images of a workspace (either visual or X-ray images), with 3D position data describing interior and/or unseen regions of the workspace.

The invention provides numerous advantages for localization during surgical and other medical procedures. The invention is relatively inexpensive to practice, since the method can be performed with a commercially available computer workstation, and/or an apparatus including such a workstation or even a so-called personal computer as the computing means. No cumbersome frame is required to be attached to the patient, as in devices of the BRW type. The system provides free hand tracking of a medical instrument during a procedure, e.g. the instrument's position can be determined without requiring that it be attached to a reference structure such as the BRW ring or any other mechanical device.

Moreover, as long as the image pairs are made from the same respective locations as the calibration image pair, nearly any feature in the workspace can be accurately localized in terms of the workspace coordinate framework. If it is desired to select new locations for making the image pairs, to provide a better view of portions of the workspace or any other reason, all that need be done is to reposition the fiducial structure in the workspace to make a new pair of calibration images. The computing means then can readily compute a new workspace framework, the fiducial structure can be removed and the medical procedure continued with a relatively short delay. These and other advantages will be apparent to those in the medical arts.

While the computations and computational sequences have been described with respect to a particular working embodiment, it will be recognized by those of skill in the arts of computing and image projection that there are many alternate types of computations and computational sequences that may be used to accomplish essentially the same result in the same or similar way. For example, algorithms for implementation of a least squares approach are many, as problem solving techniques vary and grow within the field of numerical analysis. Also, alternate projection computation methods besides that of Bopp and Krauss referenced herein, may be applied to solve the problem of mapping from a pair of 2D images to a 3D spatial framework.

It will also be apparent that other configurations of the components of the apparatus are possible and are functional to practice the invention. It will further be apparent that the precise components of the apparatus can be varied, without departing from the spirit and

concept of the invention. The claims alone define the scope of the invention.

What is claimed is:

1. Apparatus for defining a location of a medical instrument relative to features of a medical workspace including a patient's body region, comprising:

workspace imaging means positionable for producing a plurality of pairs of images of the medical workspace, each of said image pairs comprising two images made along one of each of a different one of two sightlines, said sightlines intersecting at an angle;

digitizing means operably disposed for digitizing each of said images of said image pairs to produce sets of digital image signals, one said set of digital image signals corresponding to each of said images;

fiducial means removably positionable in said workspace for providing a series of fiducial points held in fixed spatial relation to one another; and

computing means connected to said digitizing means to receive said digital image signals therefrom, said computing means being operable to:

establish a workspace coordinate framework in three dimensions from a first selected one of said pairs of images made when said fiducial means is positioned within said workspace,

determine workspace coordinates in said workspace coordinate framework of any selected point which can be identified from both images of said first selected image pair,

receive a set of scan coordinates for each of three or more selected landmarks present in a scan made in a scan coordinate framework, and correlate said scan coordinates with the workspace coordinates of said landmarks as derived from one of said image pairs, said landmarks being selected from the group of anatomic features, surgical implants, and radiologic implants,

compute conversion functions for converting the scan coordinates of a selected feature in said scan to corresponding workspace coordinates in said workspace framework, and for converting observed workspace coordinates of a selected feature observable in both of said images of a selected one of said image pairs to corresponding scan coordinates in said scan coordinate framework, and

perform said conversion functions for user-selected features found in said scan or in a subsequent selected one of said image pairs.

2. The apparatus of claim 1, wherein said computing means includes memory means for storing data including a plurality of instrument dimensions, each of said instrument dimensions comprising a known distance between a fiducial mark on an instrument and a preselected operative portion of said instrument, and said plurality including instrument dimensions for a plurality of instruments, said plurality including surgical instruments, pointers, and electrodes, and wherein said computing means is further operable to compute either extrapolated workspace coordinates or extrapolated scan coordinates of said operative portion of said instrument from said instrument dimensions and the workspace coordinates of said instrument in said image pair.

3. The apparatus of claim 2, wherein said computing means further includes computer graphics means operable to compute a plurality of sets of display signals, each said set representative of at least one of said images of

said workspace or of a volume scan, and said apparatus further includes display means communicatively connected to receive said display signals from said computing means, for displaying an image encoded by a selected one of said sets of display signals.

4. The apparatus of claim 3, further including at least one instrument having a shank and an operative portion, wherein two fiducial marks are provided on said shank, and wherein at least one distance which is the distance between one of said fiducial marks and said operative portion is stored in said memory means of said computing means.

5. The apparatus of claim 1, wherein said workspace imaging means includes one or more x-ray imaging devices, and said fiducial points of said fiducial means are formed of radio-opaque material.

6. The apparatus of claim 1, wherein said workspace imaging means comprises one or more video cameras.

7. The apparatus of claim 1, wherein said workspace imaging means comprises two video cameras.

8. The apparatus of claim 1, wherein said fiducial means includes at least six said fiducial points distributed in at least two distinct planes.

9. The apparatus of claim 8, wherein said fiducial means comprises at least four rods interconnected to form a cage-like array, each of said rods having first and second ends, and said rods disposed with said first ends in a first plane and said second ends in a second plane which is parallel said first plane, and wherein said fiducial points include at least some of said first and second ends.

10. The apparatus of claim 8, further including at least one additional fiducial point, and wherein said computing means is further operable to compute from said six fiducial points expected workspace coordinates of said at least one additional fiducial point, to determine actual workspace coordinates of said at least one additional fiducial point from said digitized signals, and to compare said expected workspace coordinates to said actual workspace coordinates.

11. The apparatus of claim 1, wherein said angle is between about 5 degrees and 175 degrees.

12. The apparatus of claim 1, wherein said computing means includes a memory component, and said memory component is constructed to contain fiducial reference data for a preset minimum number of said fiducial points of said fiducial means, said fiducial reference data comprising the physical coordinates of each individual said fiducial point.

13. A fiducial structure for establishing a three-dimensional coordinate framework from a photographic image pair, comprising a support frame and a set of fiducial indicators connected and supported by said support frame, said support frame comprising a plurality of rod-like elements interconnected to form an open cage, wherein said fiducial indicators are formed as a series of eight objects interconnected by four of said rod-like elements, with individual said objects disposed respectively near a first end of each of said four rod-like elements and near a second end of each of said four rod-like elements.

14. A method of localizing a feature of interest in a workspace, comprising the steps of:

- providing a fiducial structure comprising
  - a sufficient number of fiducial indicators arranged to define a three-dimensional coordinate system and having known 3D coordinates, and

support frame means for supporting and connecting said fiducial indicators, said support frame means constructed to hold said fiducial indicators in fixed relation to each other;

making a calibration image pair of the workspace comprising two 2D images of the workspace made along different sightlines, and with the fiducial structure positioned in the workspace such that a preset minimum number of fiducial points are visible in both images of the calibration image pair; digitizing respective 2D images of the calibration image pair;

determining a first plurality of 2D coordinates from one member of the calibration image pair and a second plurality of 2D coordinates from the other member of the calibration image pair;

computing a 3D workspace coordinate framework from said first and second pluralities of 2D coordinates and the known 3D coordinates of the fiducial structure;

removing the fiducial structure from the workspace; making a subsequent image pair comprising two 2D images of the workspace having a patient's body region therein, the two 2D images being made along the same respective sightlines as the calibration image pair;

digitizing the respective 2D images of the subsequent image pair; and

determining workspace 3D coordinates of a feature of interest in the workspace from the respective 2D images of the subsequent image pair.

15. The method of claim 14, further including the step of repeating said steps of making a subsequent image pair and determining the workspace 3D coordinates of the feature of interest, until a medical procedure is complete.

16. The method of claim 14, wherein the preset minimum number of fiducial points is six.

17. The method of claim 14, further including the steps of:

providing volume scan data reflective of a volume scan having a defined volume scan 3D framework including scan 3D coordinates for selected features;

aligning the volume scan 3D framework with the workspace 3D framework to produce a mapping function for mapping the scan 3D coordinates of a selected point to corresponding workspace 3D coordinates;

selecting a target in the volume scan and determining target workspace 3D coordinates for the target using the mapping function; and

comparing the target workspace 3D coordinates with the workspace 3D coordinates of the feature of interest.

18. The method of claim 15, wherein said step of repeating is performed for one or more different selected features of interest and one or more different targets selected from the volume scan.

19. The method of claim 17, wherein the feature of interest is a medical instrument having an operative portion, and further including the steps of computing an instrument vector representing a linear direction of the instrument, computing coordinates representative of a position of the operative portion of the instrument, and extrapolating the instrument vector from the coordinates of the operative portion for a distance sufficient to

17

determine whether the instrument vector will intersect the target.

20. The method of claim 19, wherein the calibration and subsequent image pairs are made by video imaging means.

21. The method of claim 20, further including a step of providing a visual display of the workspace comprising one image of the subsequent image pair, or a stereo image derived from both images of the subsequent image pair.

22. The method of claim 21, further including a step of overlaying an icon representing a target feature on the display of the workspace.

23. The method of claim 17, wherein the calibration and subsequent image pairs are made by video imaging means.

24. The method of claim 23, further including a step of overlaying an icon representing the target feature on the display of the workspace.

25. The method of claim 23, further including a step of providing a visual display of the workspace comprising one image of the subsequent image pair, or a stereo image derived from both images of the subsequent image pair.

26. The method of claim 17, further including a step of displaying the target and the feature of interest according to their respective workspace coordinates and in a visual context comprising an image of the workspace presented in terms of said 3D workspace coordinate framework.

27. Apparatus for localizing a medical instrument relative to features of a patient's body region, comprising:

a fiducial structure removably positionable in a medical workspace, and comprising

a sufficient number of fiducial indicators arranged to define a three-dimensional coordinate system and having known 3D coordinates, and

support frame means for supporting and connecting said fiducial indicators, said support frame means constructed to hold said fiducial indicators in fixed relation to each other;

workspace imaging means positionable for producing a plurality of pairs of images of said medical workspace, each of said image pairs comprising two images made along one of each of a different one of two sightlines, said sightlines intersecting at an angle;

digitizing means operably disposed for digitizing each of said images of said image pairs to produce sets of digital image signals, one said set of digital image signals corresponding to each of said images; and computing means connected to said digitizing means to receive said digital image signals therefrom, said computing means being operable to:

18

determine a first plurality of 2D coordinates from one member of a calibration image pair and a second plurality of 2D coordinates from an other member of said calibration image pair, said calibration image pair being an image pair made with said fiducial structure positioned in said medical workspace,

compute a 3D workspace coordinate framework from measured physical 3D coordinates of said fiducial structure in combination with said first and second pluralities of 2D coordinates,

compute an algorithm for converting any 2D coordinates derived from a subsequent image pair made after said fiducial structure is removed from said medical workspace, to corresponding 3D workspace coordinates,

determine a set of 2D image coordinates reflective of a current position of a feature of interest present in both images of said subsequent image pair, and

convert said set of 2D image coordinates to a set of corresponding workspace 3D coordinates.

28. The apparatus of claim 29, wherein said feature of interest is a medical instrument having an operative portion, and said computing means is further operable to compute an instrument vector representing a linear direction of said instrument, to compute coordinates representative of a present position of said operative portion of said instrument, and to compute extrapolated vector coordinates from said coordinates of said operative portion and said instrument vector at a distance from said operative portion sufficient to determine whether said instrument vector intersects said target.

29. The apparatus of claim 28, wherein said computing means is further operable to:

receive volume scan data reflective of a volume scan having a defined volume scan 3D framework;

correlate said volume scan 3D framework with said workspace 3D framework to produce a function for mapping scan 3D coordinates of a selected point to selected point workspace 3D coordinates; determine target workspace 3D coordinates for a user-selected target by applying said mapping function to said scan 3D coordinates of said selected point; and

compare said target feature workspace coordinates and said selected point workspace coordinates.

30. The apparatus of claim 28, further including display means operably interconnected with said computing means and said workspace imaging means for providing a visual display of said medical workspace, said visual display comprising one of said images of said subsequent image pair, a stereo image derived from both images of said subsequent image pair, or an image derived from said volume scan data.

\* \* \* \* \*

60

65

UNITED STATES PATENT AND TRADEMARK OFFICE  
**CERTIFICATE OF CORRECTION**

PATENT NO. : 5,389,101

DATED : February 14, 1995

INVENTOR(S) : Heilbrun et al.

It is certified that error appears in the above-identified patent and that said Letters Patent is hereby corrected as shown below:

In Column 3, line 15, change "present" to ~~presently~~;

In Column 3, line 63, change "pairs" to ~~pair~~;

In Column 7, line 43, delete the hyphen between "derive" and "transformation" and insert a space therefor;

In Column 11, line 22, change "uses" to ~~use~~;

In Column 16, line 33, change "14" to ~~17~~;

In Column 18, line 34, change "28" to ~~27~~.

Signed and Sealed this  
Eighteenth Day of July, 1995

Attest:



BRUCE LEHMAN

Attesting Officer

Commissioner of Patents and Trademarks